

PROPELLER BOLTS PATTERN
SCALE 1:1

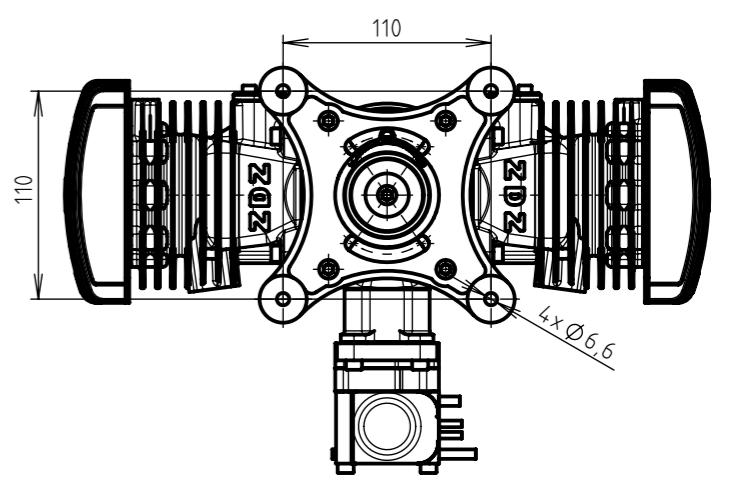
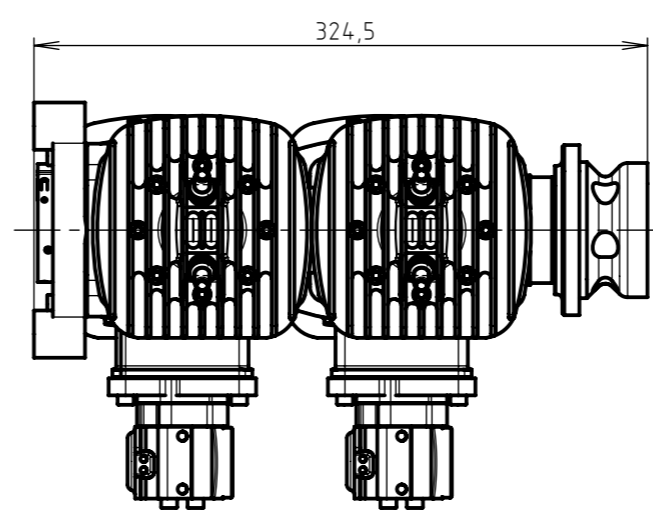
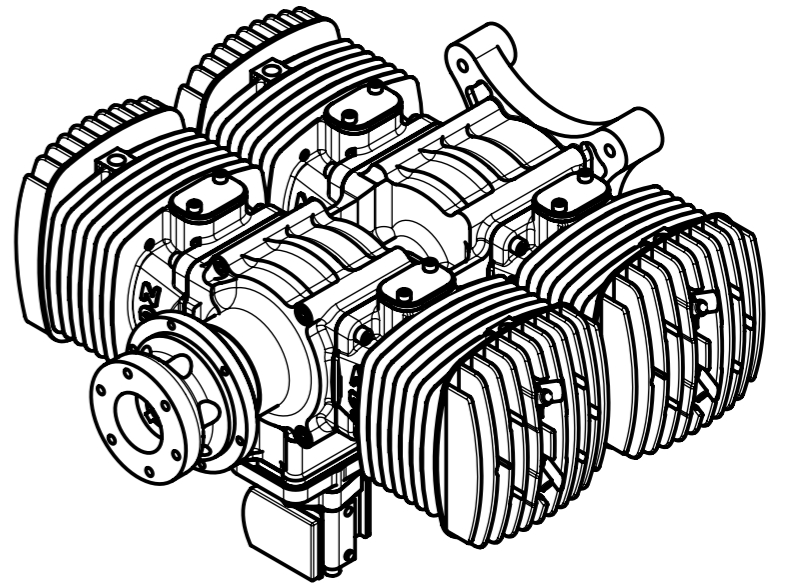
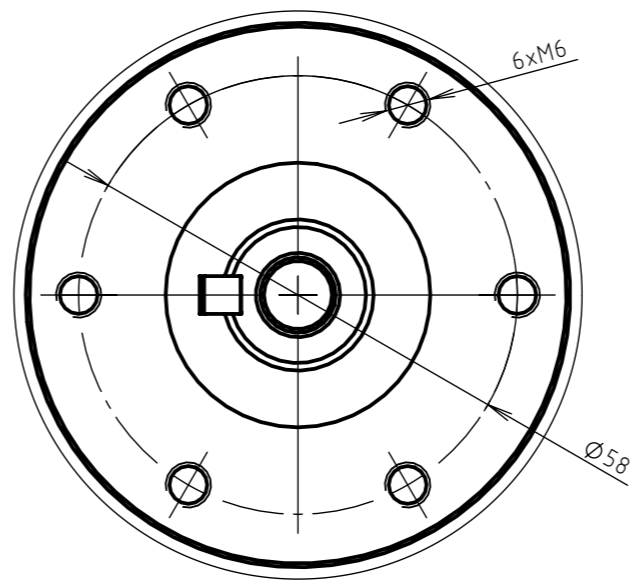

Struktura povrchu:	Hrany:	Měřítko 1:4	Přesnost ISO 2768-mK
			Tolerování ISO 8015
			Promítání
Materiál	Polotovary	Hmotnost g	CHRÁNĚNO PODLE ISO 16016
 757 01 Poličná 543, CZ tel. +420 778 001 860	Druh dokumentu DIMENSIONS	Název 420/500B4-JCH 2021	
	Kreslil	Číslo dokumentu	
	Item	Formát: A3 List 1 / 1	
	Datum vydání 29.7.2021	REV.	